









340 KATANA X-CNC-LR 34×1,1

						
0°	30°	45°	60°	30°	45°	$\frac{b}{a \times b}$
	350	350	350	230	350	350
	500x340	500x340	380x340	220x340	480x340	350x340
						500x180

				
3×400V 50 Hz	3,0	20-100	4780×34×1,1	2150

Lmin	Lmax	Bmin	Bmax	Hmin	Hmax	V
2500	3030	2720	3150	1870	2000	800



340 KATANA
X-CNC-LR

STANDARD OPTION

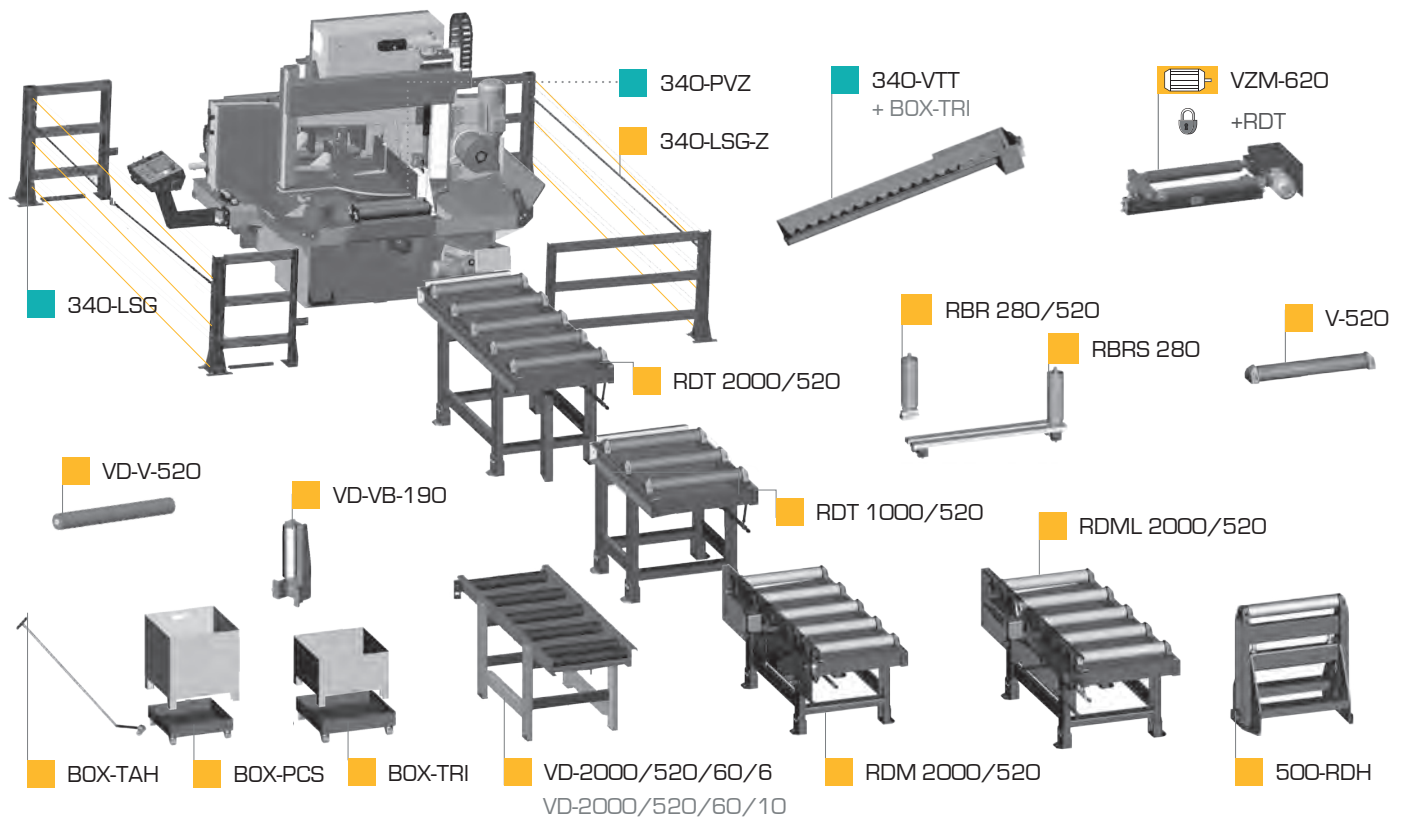
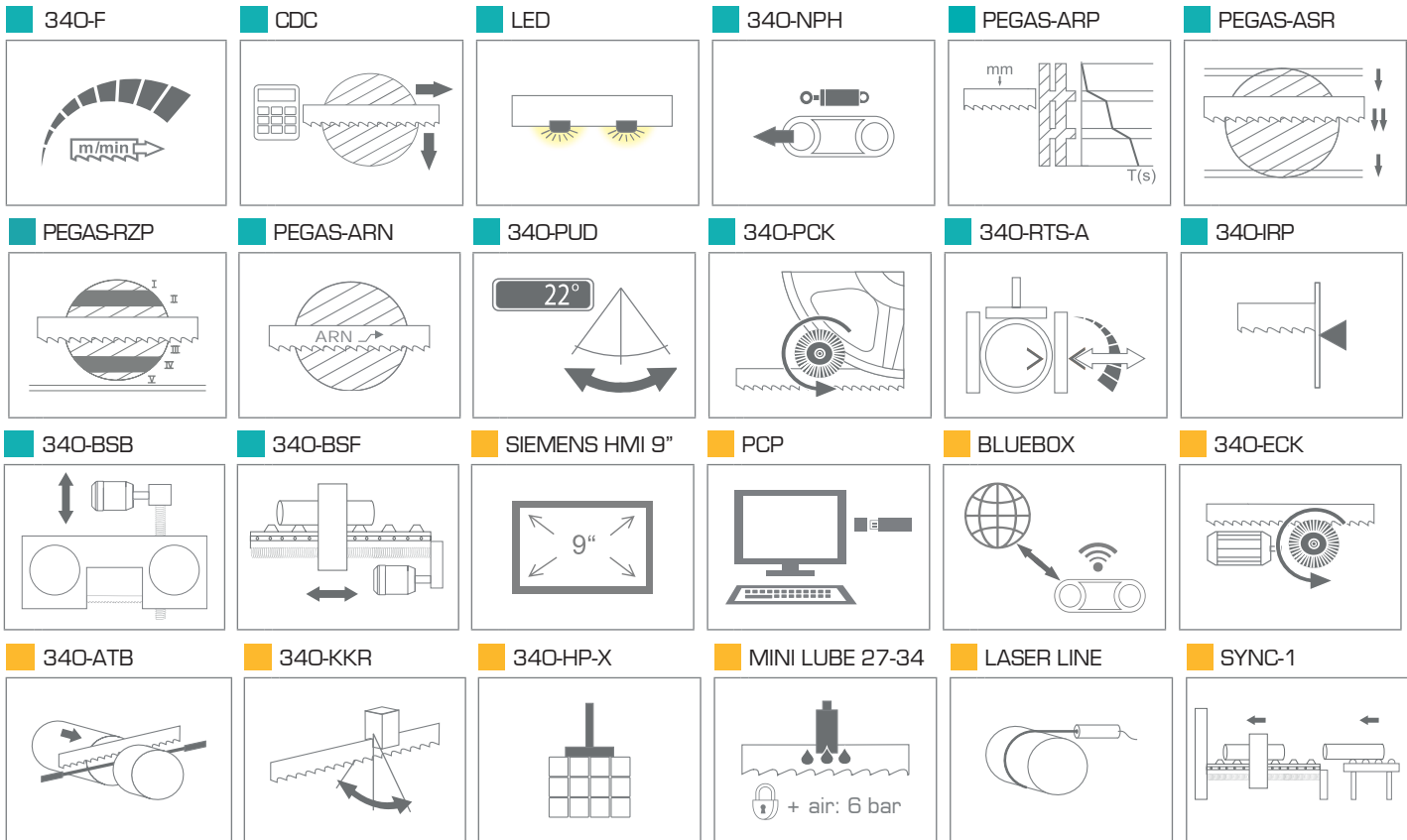

CONTROL PANEL: SIEMENS (X-CNC)

340 KATANA X-CNC-LR

- výrobce si vyhrazuje právo provádět změny technických údajů, technické údaje odpovídají 1.1.2023 / producer has the right to make changes of technical data, technical data are valid on 1.1.2023

- pila na fotografii není vždy v základním provedení, uvedené rozměry odpovídají stroji v základním provedení / the machine in the picture is not always in the basic version, mentioned diameters are for machine in basic version

* doporučená hodnota. Při překročení doporučeného maximálního průměru není možné garantovat výkon pilového pásu! / recommended value. The blade performance cannot be guaranteed when the recommended diameter is exceeded!

- řezání svazků bez horního přitlaku / cutting of the bundle without top clamping



PEGAS - GONDA s.r.o.
Čs.armády 322, 684 01 Slavkov u Brna,
CZECH REPUBLIC

www.pegas-gonda.cz
00420-544 221 125 (126) | pegas@gonda.cz